

# OCULAR

## Ocular IQ Solar



IOCAW13-7S-SOLAR/ IOCAW13-7T-SOLAR  
IOCAW13-22S- SOLAR/ IOCAW13-22T-SOLAR

Direct CT Solar Connection

Direct Load Control

Ocular Smart App

Indoor and Outdoor Rated

Stay in the know with a LCD screen

Fast, sustainable and compatible with every EV in Australia. Meet the Ocular IQ Solar. The Ocular IQ Solar is an intelligent solution to utilise your home solar system. Use all the power you produce instead of exporting to the grid.

### Main Features

#### Unique Design

2.8" LCD display for excellent clarity and LED indicator

#### Flexible output current

Output current adjustment via back office

#### Multiple Charging Standard Compliant

Type-1 connector, Type-2 connector or Type-2 socket

#### Ocular Home App

Comes with a free home OCPP app to fully manage your solar charger

#### 2 different Models

1-phase 7kW & 3-Phase 22kW available

# Specification

Model	IOCAW13-7S / IOCAW13-7T   IOCAW13-22S / IOCAW13-22T	
Input Voltage & Current	230V±20%, 32A per phase	
Frequency (Hz)	50/60Hz	
Charging Connector	Type-2 socket/ Tethered cable	
Power Output	7.2kW (1- Phase)	22kW (3- Phase)
Output Voltage	230V ± 20%	400V ± 20%
Output Current	32A MAX per phase	
Display	2.8" LCD screen	
User Authentication	RFID Card, Mobile App, Remote Access	
Operating Temperature	-30°C to +55°C in operation	
Storage Temperature	-40°C to +75°C in storage	
Working Humidity	95% relative humidity, non-condensing	
Internal RCD	30mA AC & 6mA DC	
IP Performance	IP55	
Meter	MID Meter	
Internet connection	Ethernet + Wi-Fi	
Mounting	Wall-Mount/ Pole-Mount	
Charging Cable Length	Tethered model only - 5m	
Dimension (H x W x D, mm)	380 x 288 x 160 mm	
Net Weight	(1- Phase) 5.3 kg (socket type) 7.8 kg (tethered)	(3- Phase) 5.4 kg (socket type) 8.1 kg (tethered)
Recommended circuit breaker	40A single phase type A RCBO	40A three phase type A RCBO
Recommended cable size (50m run)	10mm <sup>2</sup> 2C+E	10mm <sup>2</sup> 4C+E
Certificate	CE, IEC /EN 61851-1, IEC/EN 61851-23, IEC/EN 61851-21-2, RCM	
Warranty	2 years	
Electrical Protection	Over current, Short circuit, Over voltage, Under voltage, Ground fault, Lightning Surge, Over temperature	

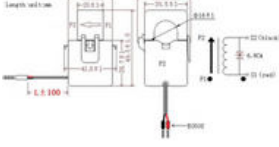
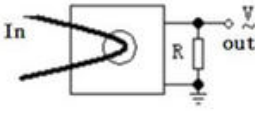
Description	Current Transformer		
Rated Current Ratio	<b>100A:50mA</b>		
TYPE	<b>IOCCT100</b>		
<b>Electrical Specifications</b>		<div style="text-align: center;"> <b>Mechanical Dimensions in mm</b> </div>  <p style="text-align: center;"><b>Same polarity: *--*</b></p> <p style="text-align: center;"><b>Direction for use:</b></p> 	
Rated Primary Current (A)	100A		
Secondary Current (mA)	50mA		
Maximum Current I <sub>max</sub> (A)	120A		
Rate Transformation Ratio	2000:1		
Power-Frequency Withstand Voltage	4000 V <sub>rms</sub>		
Current Error	±0.5%		
Rated Phase Displacement	≤80'		
Rated Frequency	50/60Hz		
Rated Short-Time Thermal Current	400A (≤1s)		
Rated Resistive Burden (Ω)	≤ 20Ω		
Insulation Resistance (MΩ)	> 500MΩ		
<b>Mechanical Specifications</b>			
Encapsulant	Epoxy Resin		
Weight (g)	110g		
Tolerance (mm)	±1.5		
Storage Temperature (°C)	-40°C<T<+85°C		
Working Temperature (°C)	-25°C<T<+75°C		
Working Humidity	0-90% (no condensation)		
Enclosure Flame Retardant Grade	UL94 V-0		

# OCULAR

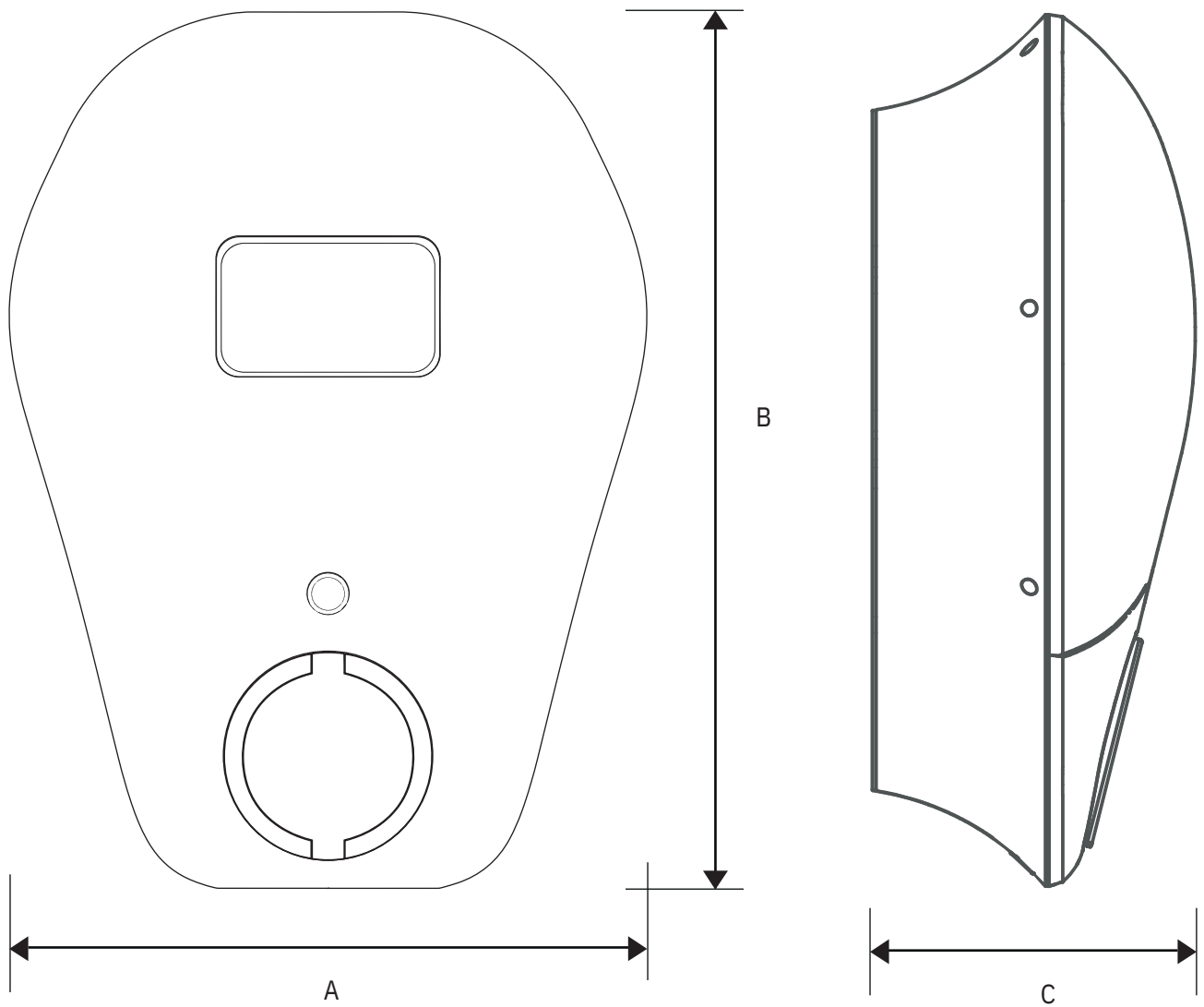

Size (mm)	A	B	C
288 x 380 x 160	288	380	160

# OCULAR



Cable Management System (wrap cable around unit)

2.8" LCD Screen

RFID Card Reader

OCPP Compatible

Heavy Duty Plastic Casing

Load Control

Status Lighting

Solar Integration

Compatible with every EV

Universal Dual Type 2 Socket (or) 5m cable hardwired



OCULAR

# IQ SOLAR FAQs

## **What's the difference between the 7kW and 22kW?**

The 7kW version is best for a single-phase power supply to your home, whereas the 22kW version works best with three-phase power. If you're not sure what type of power supply you have in your home, please speak to your electrician. The unit is available with a universal socket or with a 5m Type 2 cable.

## **When should I choose a Single or Three-phase IQ Solar?**

We recommend matching your charger to the Solar systems output. Ie if you have a single-phase solar system choose a single-phase IQ Solar.

## **Can the 3-phase Ocular IQ Solar be connected to single-phase only?**

Yes, it will act like a standard single-phase charger. Just 1 CT input will be available to use.

## **Can we charge a single-phase capable EV with a 3-phase Ocular charger?**

Yes, absolutely!

## **Is the Ocular IQ Solar compatible with all EVs?**

Yes, every EV in Australia.

## **When am I exporting electricity?**

On the Ocular App, look at the Energy tab. A negative value indicates you are exporting to the grid (excess solar), while a positive value indicates you are consuming electricity from the grid. Remember, the Solar Only Mode requires your home to be exporting excess solar to the grid. See Solar Only mode below.

## **Does the Ocular IQ Solar work with any solar system?**

Yes. If you have a solar system that is constantly exporting electricity to the grid, then the Ocular IQ Solar will allow you to use that excess solar efficiently to recharge your vehicle's battery. We use a CT to measure the excess solar being sent to the grid in real time.

## Does the Ocular IQ Solar work with any solar system?

Yes. If you have a solar system that is constantly exporting electricity to the grid, then the Ocular IQ Solar will allow you to use that excess solar efficiently to recharge your vehicle's battery. We use a CT to measure the excess solar being sent to the grid in real time.

### How the Ocular IQ Solar understands your homes electricity usage

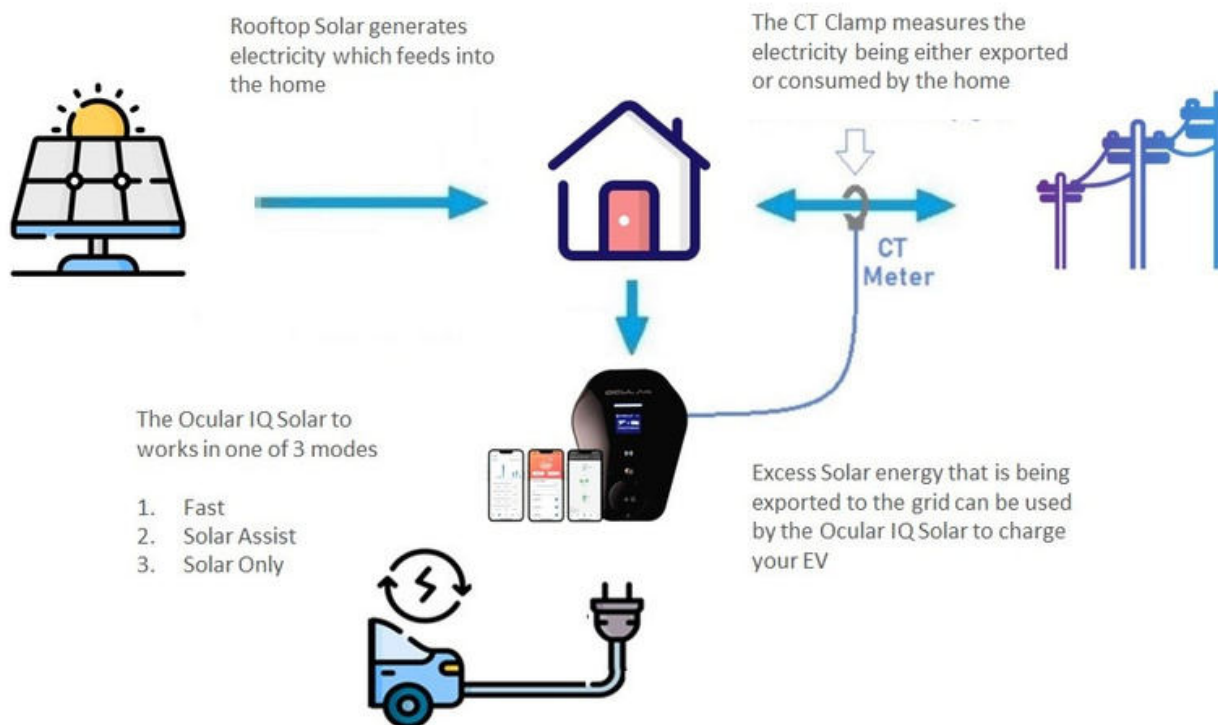

## How many CT clamps are provided?

One CT for single-phase versions and three for three-phase versions. You must only use the CT clamps provided or an approved CT from the Ocular team. This is to ensure that the solar and load control readings are accurate at all times. CTs are supplied in the charger box.

## What happens if I have a stationary storage home battery?

For the most part, any excess solar produced by the system will be absorbed by the battery. The Ocular IQ Solar modes work by using CT clamps to understand what you are exporting out to the grid. You may find that the home battery is absorbing most of your excess solar generated first and so what's going out to the grid is minimal. Despite this, it's fine to still install a charger, but you may find the Solar Assist mode best to draw a small amount from the grid/battery when no excess solar is being produced. If there is excess solar available, it can then utilise the available excess solar that the battery is not taking.

### **How many CT clamps are provided?**

One CT for single-phase versions and three for three-phase versions. You must only use the CT clamps provided or an approved CT from the Ocular team. This is to ensure that the solar and load control readings are accurate at all times. CTs are supplied in the charger box.

### **What does each charging mode do?**

The Ocular IQ Solar is designed to offer flexibility through three (3) charging modes: Fast, Solar Assist or Solar Only.

For solar charging our preferred mode is Solar Assist as it always ensures a baseline load + excess solar.

#### **Fast Mode:**

In this mode, the vehicle will be charged at maximum power. This power can come from a renewable energy source or the grid. If you have set a current limit on the schedule or by the electrician during installation that will determine maximum power.

#### **Solar Assist:**

This mode will charge your EV at a minimum of 6 Amps plus any excess solar produced. If solar production is low, power will be drawn from the grid.

This is the preferred solar mode, particularly on cloudy days or when you have a smaller solar system. This will ensure a continuous charge plus any excess solar that your home generates.

#### **Solar Only:**

This mode charges your EV only when excess solar is produced. Please note a minimum excess of 7 Amps is required to use this mode to prevent excessive starting and stopping of the charging session which is not recommended.

If the solar production drops below 6 Amps the charging will pause and then restart after 2-3 minutes of continuous excess solar above 7 Amps.

We recommend this mode when you have a clear excess of solar power produced. Use Solar Assist when your production is low or intermittent.

A very minimal amount of power may be taken from the grid for a short period of time if solar production drops suddenly. The charging will cease until such time that a clear excess is once again available.

Our experience shows that large variable loads like air conditioning can absorb most of the solar generation. Use the Energy tab on the Ocular App to understand the excess available and choose the Solar Assist mode if excess generation is consistently below 7 Amps.



Note that smaller solar systems or cloudy days may result in only a small amount of electricity going into the vehicle or none at all. Use Solar Assist when your production is low or intermittent.

For 3-phase you need excess in each phase to enable this mode to ensure a balanced electricity supply to the unit. The lowest export value will determine the maximum speed. For single-phase only one (1) value will be shown on this screen.

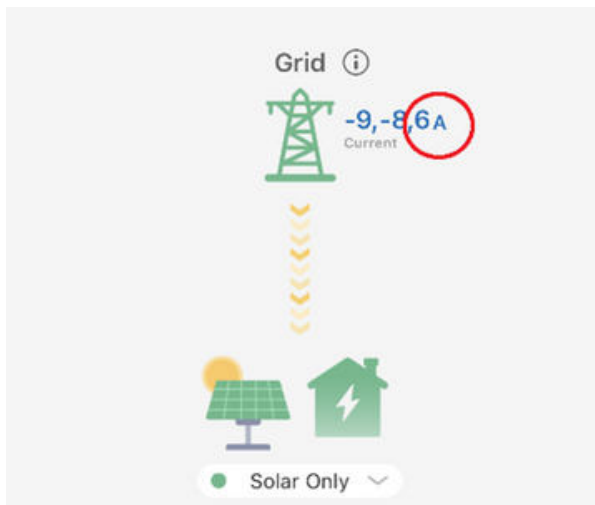

Solar Only mode will not work as phase three (3) is + 6Amps. This means that there is no clear excess across each of the 3 phases. The home is using 6 Amps from the grid, while the other two (2) phases are exporting. We need all three (3) phases to export greater than 7 Amps for this mode. Solar excess is indicated by a negative (-) value.

**In this case, choose Solar Assist or Fast Mode if you would like to charge your car.**



Solar Only mode will only work when all three (3) phases are exporting. The Solar Only mode will work at a maximum of 8 Amps as this is the smallest export phase.

## When Should I choose Fast, Solar Assist or Solar Only

The key here is to know how much your solar is producing and when you need your car to be fully charged. The charger prioritises the home's use of excess solar first. Eg. the oven, TV, kettle and air conditioner. A negative value indicates you are exporting to the grid (excess solar) while a positive value indicates you are consuming electricity from the grid. Remember the Solar Only mode requires your home to be exporting excess solar to the grid.

### Fast Mode

Switch to Fast Mode on the Energy tab of the App to charge at the fastest rate. In this mode, the vehicle will be charged at maximum power. This power can come from a renewable energy source or the grid. This mode charges your battery quickly when you don't have time to wait or in the evening when you have no excess solar.

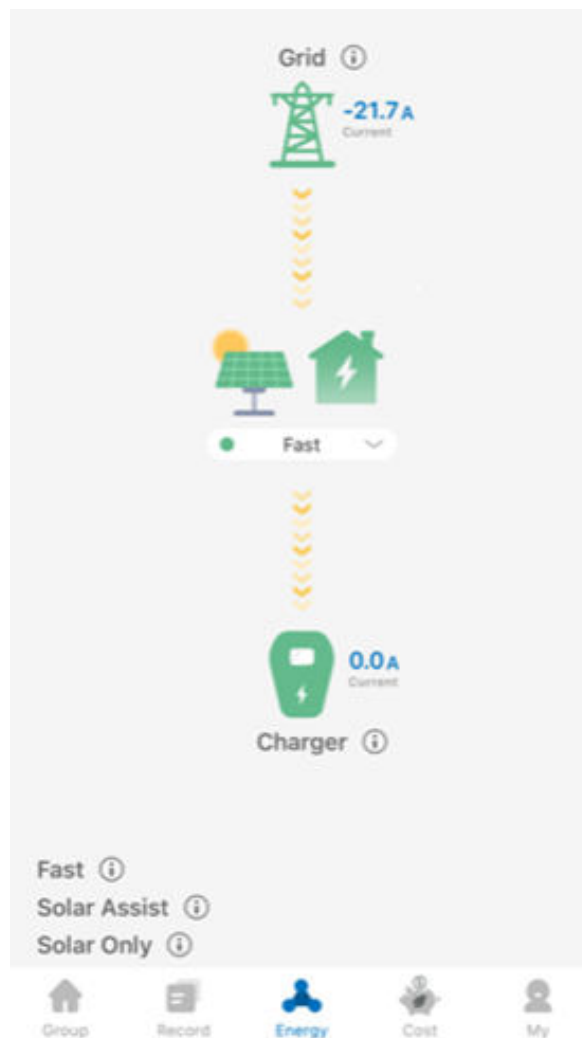

## Solar Assist

This is the ideal mode for solar users. Solar Assist mode balances usage of excess solar but avoids the potential of starting and stopping during a charging session due to fluctuations in your energy generation. As shown in the examples, the three-phase charger has only two (2) phases exporting 10 Amps while one (1) phase is only exporting 1 Amp. In Solar Assist, this will still allow for a charge allowing you to charge at 6 Amps per phase. In Solar Only, all three (3) phases would need to export more than 7 Amps to work (displayed -7 on the App).

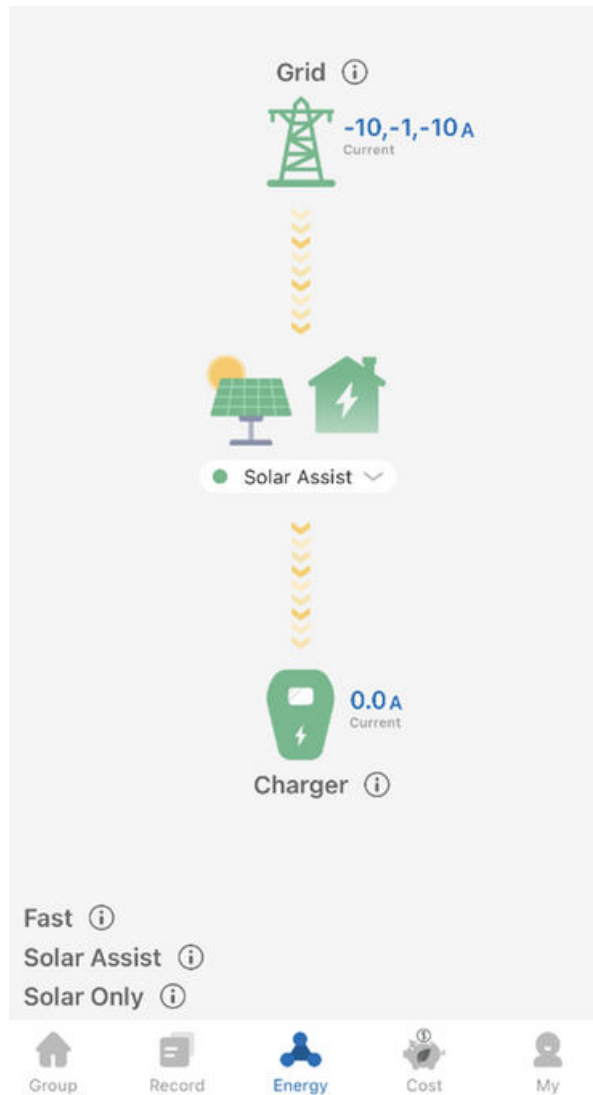

## Solar Only

The ideal mode if you have a large solar system that produces a clear excess, in order to efficiently use your energy that has been generated, minimising the use of grid energy. The example below shows a clear -21.9 Amps excess solar which is ideal. Avoid this mode when you have high variability in solar export such as a very cloudy day, small excess solar (consistently around 0 to -8 Amps).



Don't use the Solar Only mode when solar export is low as shown below. Charging will be paused or possibly start and stop continuously due to low export. Solar Assist or Fast Mode recommended to have a stable charge.

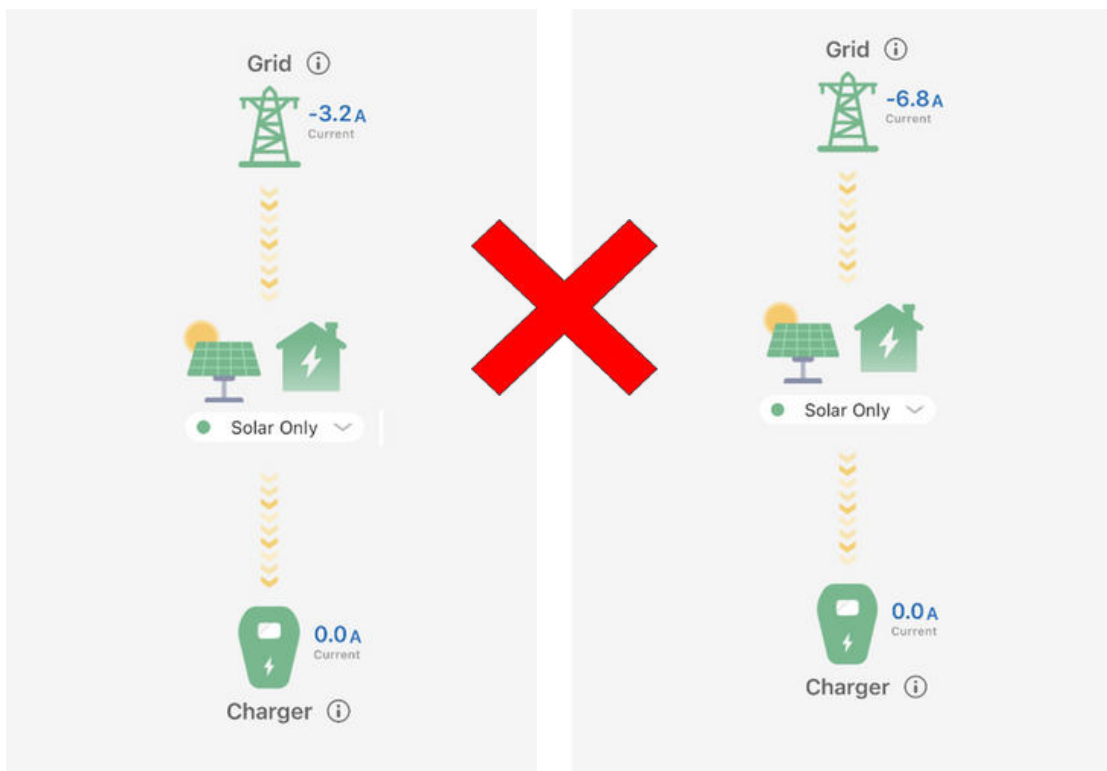

### **Can I use my own installer?**

If you wish to use your own installer, they must be a fully qualified electrician. Ocular cannot be held responsible for any issues or failures of any products caused by the installation process or from a result of an incorrect setup and configuration. We highly recommend you engage one of our trained and authorised installers to ensure the unit is connected correctly the first time. All installers must be trained and certified by Ocular prior to installation or the warranty will be void.

### **What is load management?**

The Ocular IQ Solar CT Clamps can perform both solar and load management. If set up by the electrician, it can indicate the home's electricity supply capacity. The Ocular IQ Solar will then balance the charging speed based on the real-time load in the house to prevent the home's electricity from overloading.

### **Do I need solar to use the Ocular IQ Solar?**

No, the hardware unit can be operated as a smart EV charger that can still schedule, record and monitor all your charging sessions. Solar modes or CTs can be connected in the future for an added cost.

### **What happens if my charger goes offline or losses internet?**

If the unit goes offline the charger will actively try to re-connect. However, in cases where there is poor WIFI or a password change, this will mean the charger appears offline on the App. If you have "plug and charge" set on the App, the system will still work but in a basic mode in the last available configuration.

If you change your internet password you will need to refer to the installation guide to reset it.

### **How do I get internet to the charger?**

There are 2 methods.

1. Ethernet CAT 6 cable to your internet modem.
2. WI-FI to the charger – Please note a minimum of 4 bands is required to have a strong and stable connection. Installer will need to enter the WIFI name and password into the charger backend.

### **Where do I download the Ocular App?**

The Ocular App is required to use the charger. Click on the Apple or Google App store to download the Ocular App or search via your relevant app store.



### **Can you schedule a charging session?**

Yes, you can schedule multiple sessions per day and also adjust your charging speed. Take advantage of solar daytime charging or schedule to charge off-peak. You must be plugged in before the start time for the schedule to work. Otherwise, you need to press start on the App.

### **Do I have to be plugged into the charger before a scheduled App charging session?**

Yes, you must be plugged in before the start of the App scheduled session to have the schedule function work. Eg. if you set a schedule from 6 pm to 7 pm you must be plugged in before 6 pm for the scheduling to start. If you plug in after 6 pm then you need to press the start button on the App to start a charging session. This will override the schedule for the individual charging session for the day.

### **Is the Ocular IQ Solar OCPP compatible?**

Yes, the Ocular IQ Solar is OCPP compatible. Please note, if an OCPP software platform is enabled on the charger, the Ocular App and some of the local functions of the unit will not be available.

### **Does the unit connect directly to a home battery?**

The unit does not connect directly to the battery. It uses CTs to monitor the excess solar being exported to the grid at the home's switchboard. We do not connect directly to any battery system.

### **Will the Ocular IQ Solar work with off-grid solar systems?**

No. We require a grid connection to ensure reliable charging. A very minimal amount of electricity may be taken from the grid for a short period of time if solar production drops suddenly.

### **What is the refresh rate for the energy tab?**

The energy tab will be refreshed every 30 seconds via the cloud servers which are hosted in Australia.

### **How far can the charger be from my electricity supply?**

The unit must be installed within 15 metres of your home's electricity box which is exporting electricity. The CT clamps are configured for accuracy and a distance greater than 20m can affect the accuracy of the readings.

### **How do I connect my charger to the internet?**

For connecting these chargers to the internet we recommend a hardwired connection or a full wifi connection. If either of these is unable to be implemented then we recommended a TP link wifi extender. It is the homeowner's responsibility to supply a reliable internet connection.

**For any other questions please contact  
the Ocular Team**

---

[sales@ocularcharging.com.au](mailto:sales@ocularcharging.com.au)

1300 912 650